

 P.L.E.A.S.E.[®]
P R O F E S S I O N A L

Sven Rohmann, Bio-Europe 2011, Duesseldorf, Germany

The breakthrough device
for transdermal drug
delivery

pantec
biosolutions



Disclaimer

All statements, other than statements of historical fact, made in this presentation and in any verbal statement provided in the course of delivering this presentation regarding the strategy, future operations, financial position, future revenues, projected costs, prospects, timelines, plans and objectives of management of Pantec Biosolutions AG ("Pantec"), are "forward looking" statements.

These forward looking statements refer to expectations, projections or other characterizations of future events or circumstances. Although Pantec believes that the expectations reflected in any forward looking statement made in this presentation and in any verbal statements provided in the course of delivering this presentation are reasonable, such statements are based on a number of assumptions which may prove to be incorrect, including, but not limited to assumptions relating to any risks or uncertainties.

Accordingly, no assurances can be given that any of the events or circumstances contemplated by any such forward looking statements will transpire or occur, or, if any of them transpire or occur, what impact they have on Pantec's results of operations or financial condition.

Skin structure

Skin structure and layers

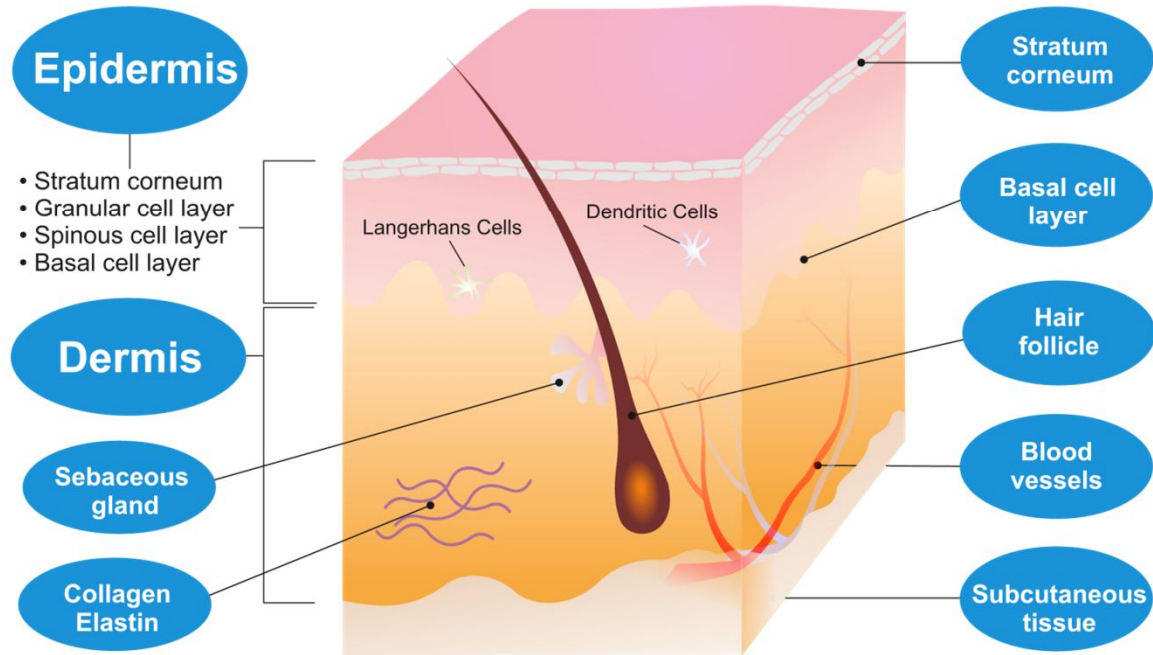

Intra - and transdermal Drug Delivery

The **SC** skin barrier

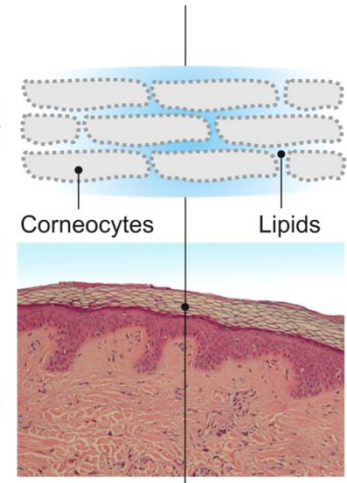

The stratum corneum layer is acting as a very strong barrier.

Physiochemical constraints effectively limit the passive permeation of many known therapeutics.

Laser to create ultra-precise micropores

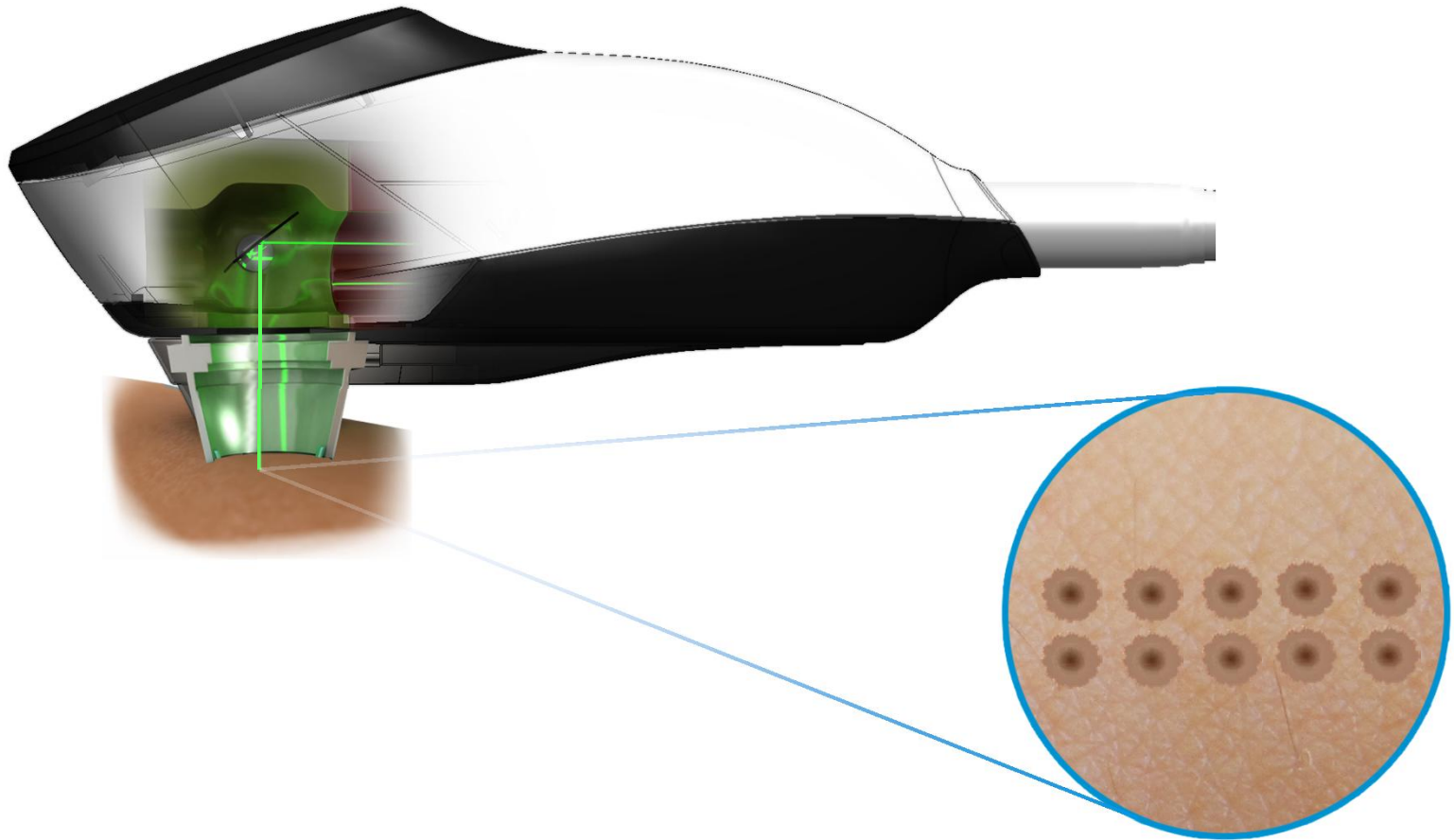

Modifications of micropores

Quality requirements:

Intra - and transdermal Drug Delivery

High-precision pore geometry

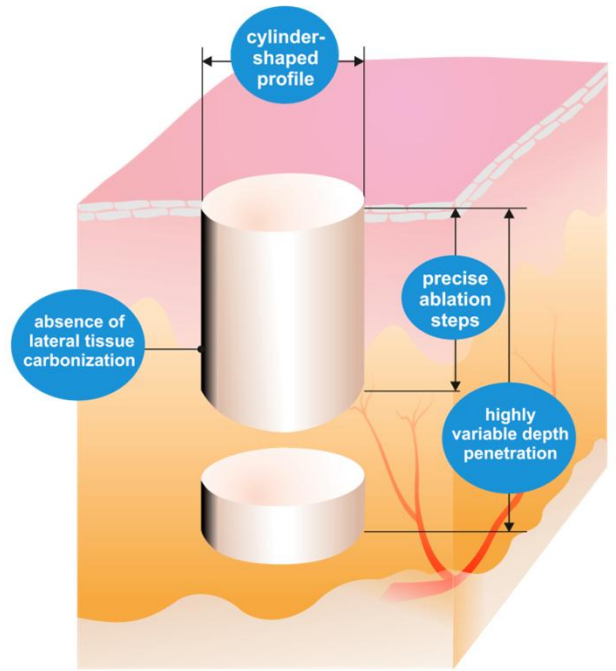

P.L.E.A.S.E.® Delivery of large molecular drugs

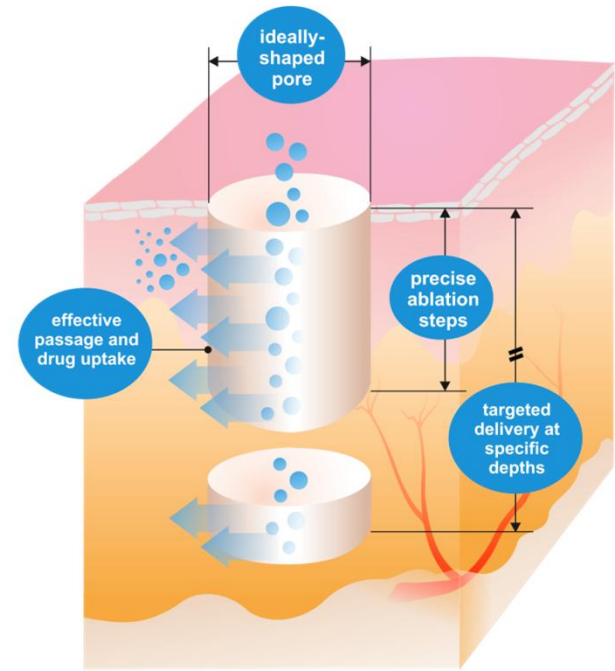

Modifications of micropores

Precisely controllable micropore density

Intra - and transdermal Drug Delivery

Adjustable skin permeation levels for precise amount control of substance delivered over time

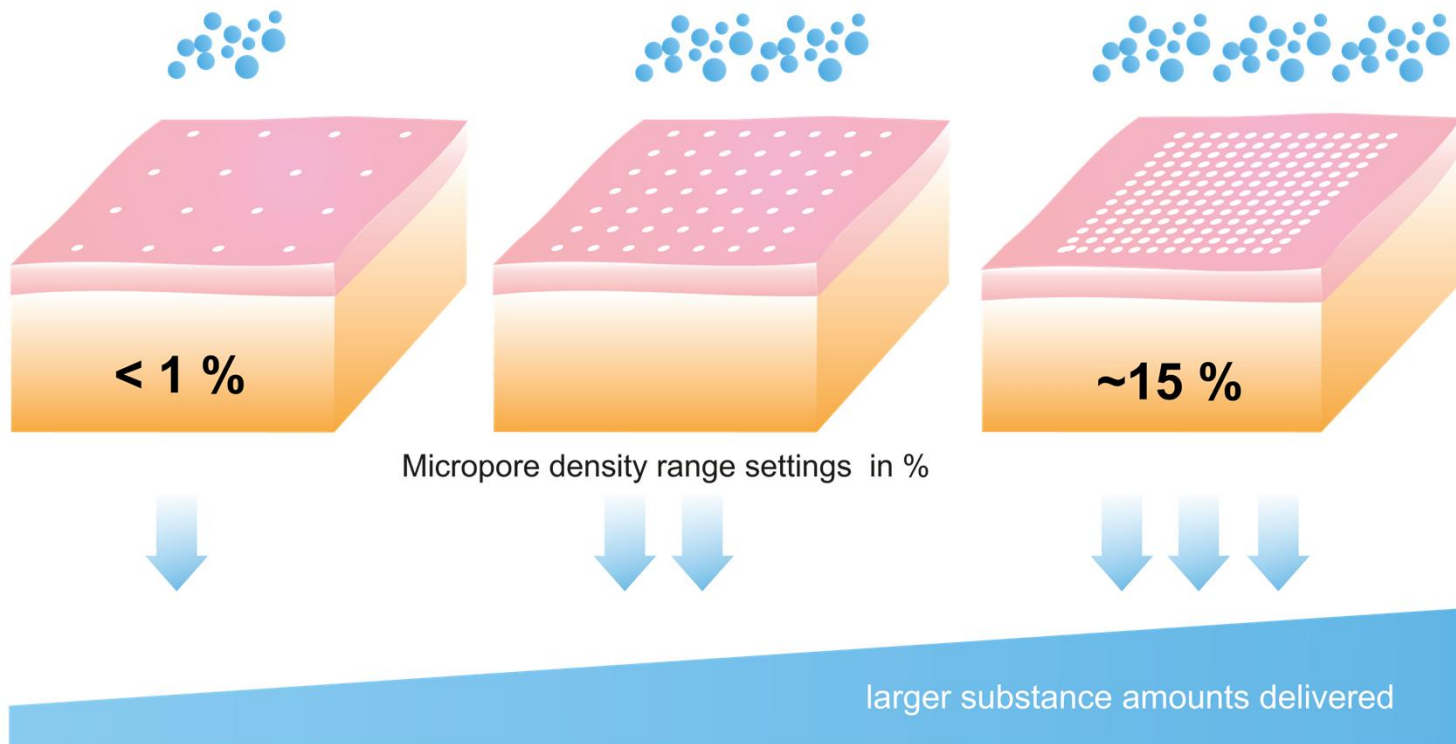

Modifications of micropores

Standard ablative laser vs. P.L.E.A.S.E.® Professional

Ideally addresses intra- and transdermal drug delivery requirements

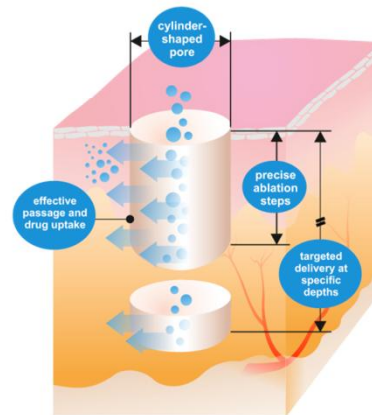
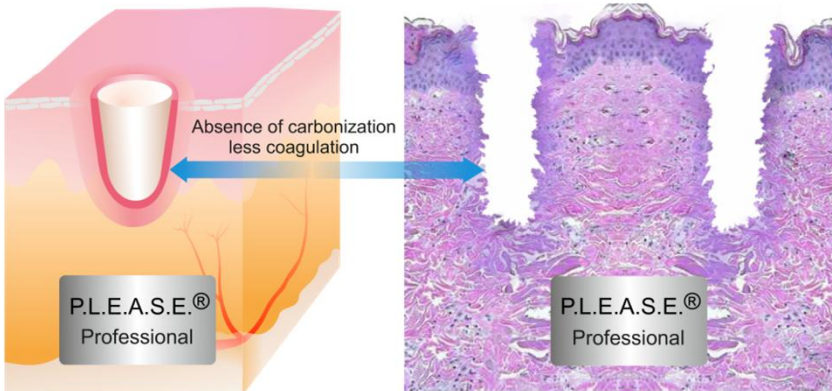
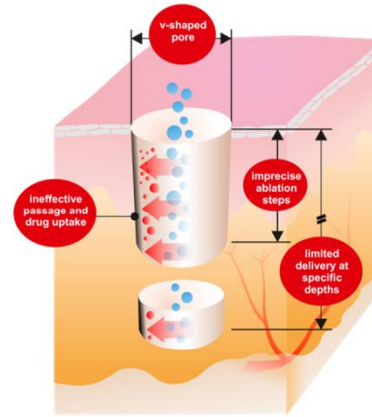
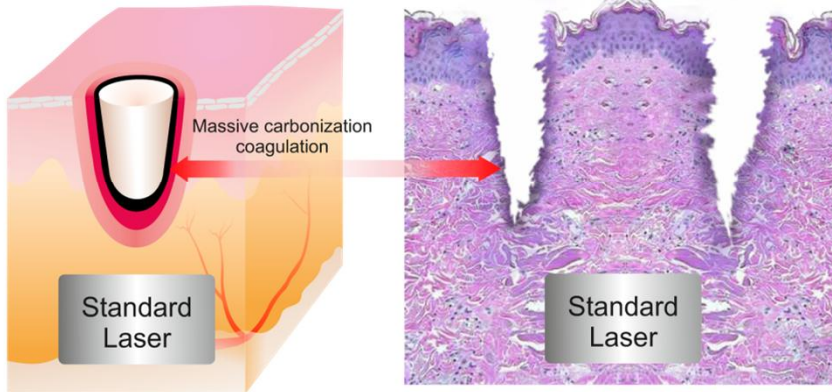

Skin structure

P.L.E.A.S.E.® Professional

Intra - and transdermal
Drug Delivery

Modification of Micropores

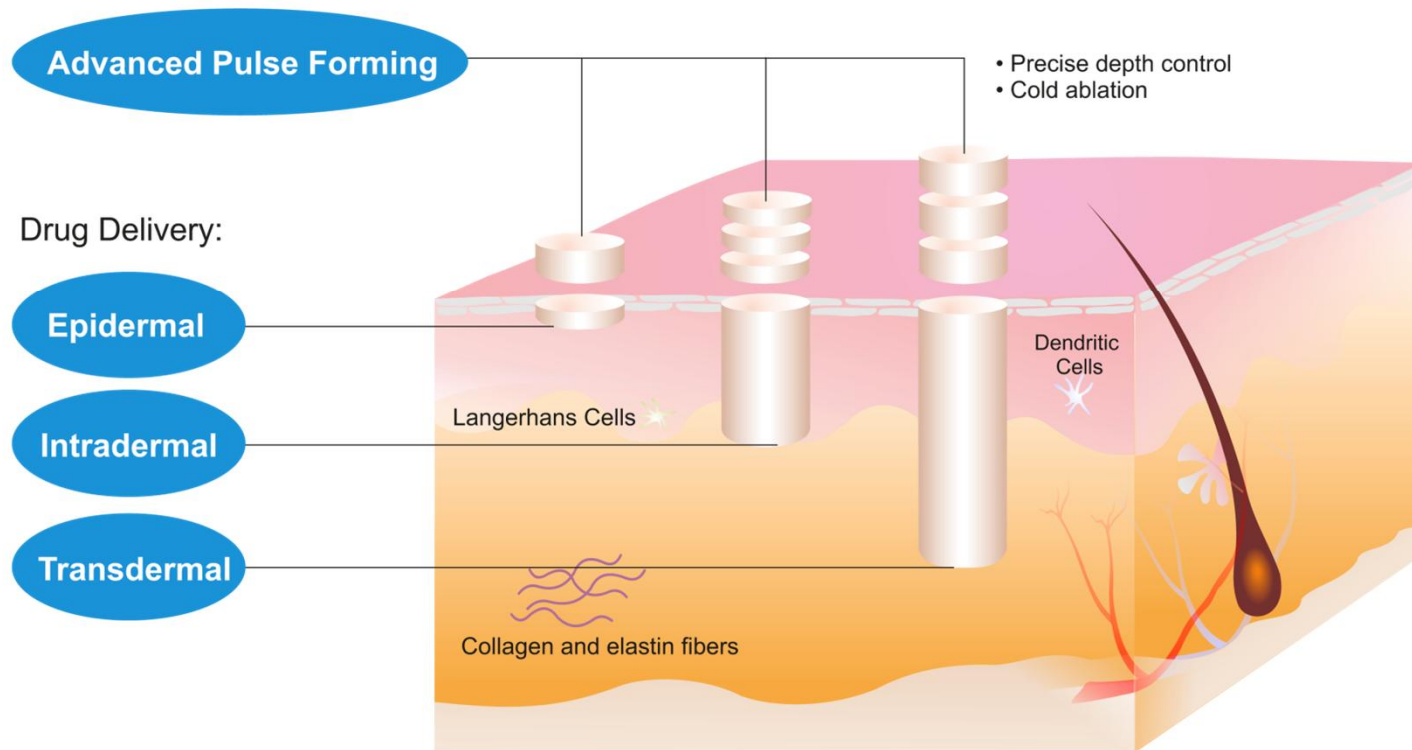

Skin structure

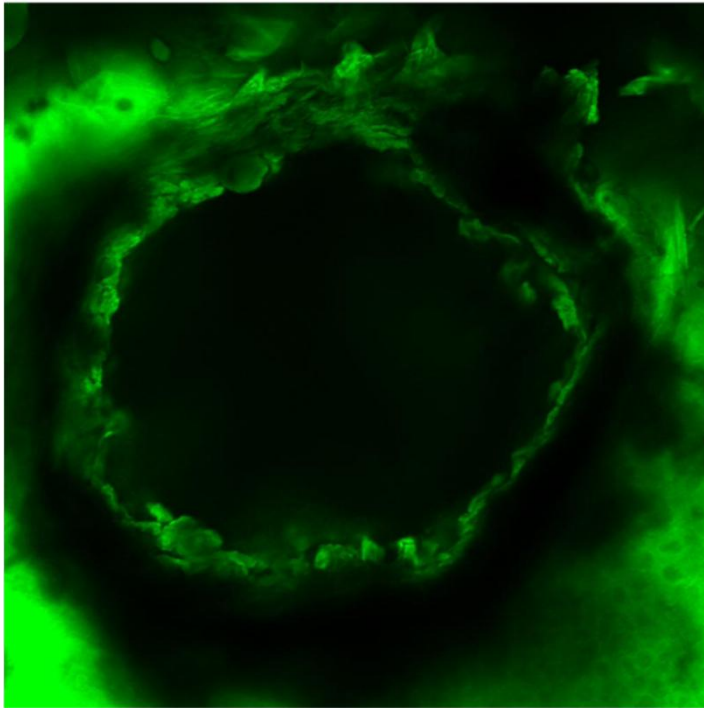

XY-image of the P.L.E.A.S.E.® micropore created in porcine skin.

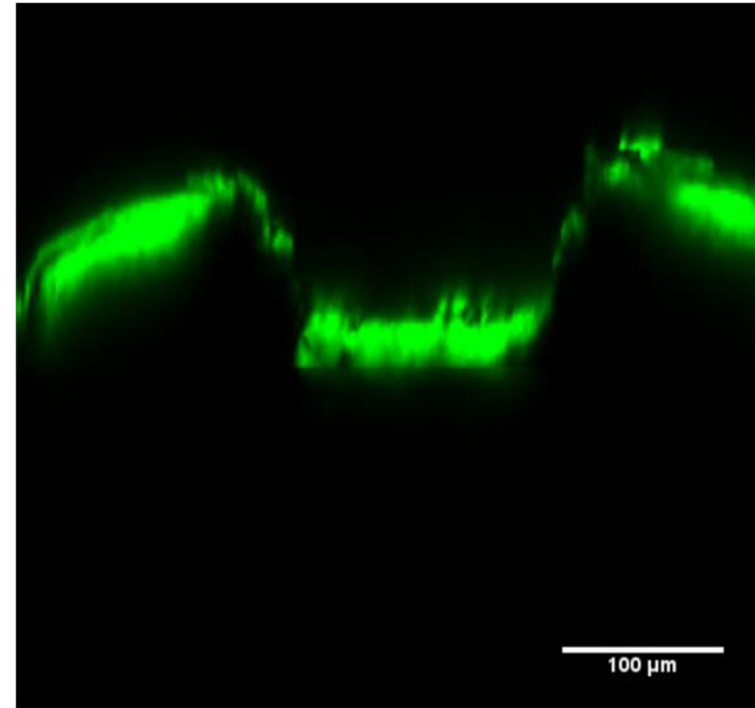

XZ-cross section of the P.L.E.A.S.E.® micropore created in porcine skin.

Transdermal delivery without molecular size limitation

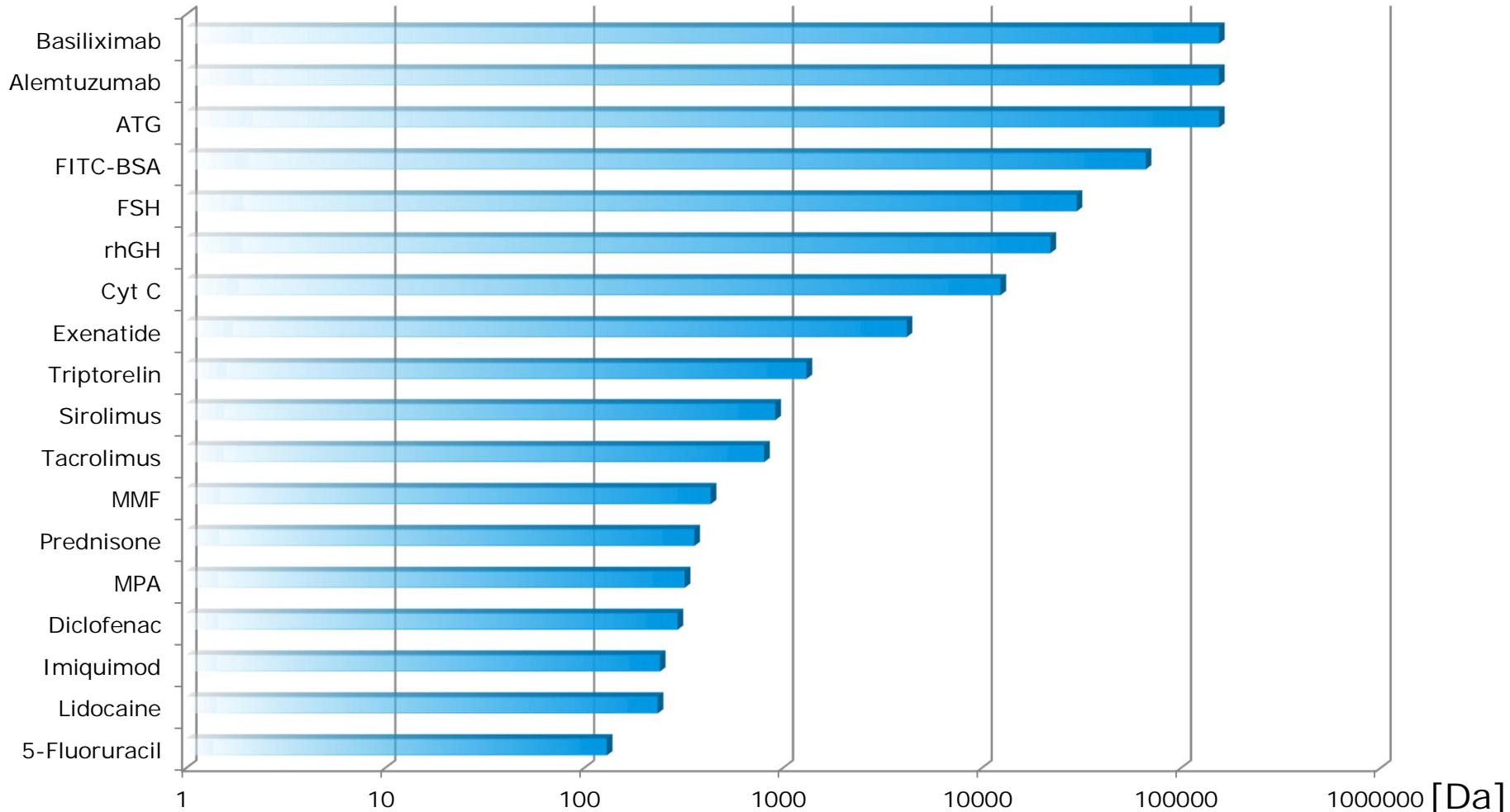

Transdermal delivery of FSH in women (clinical POC)

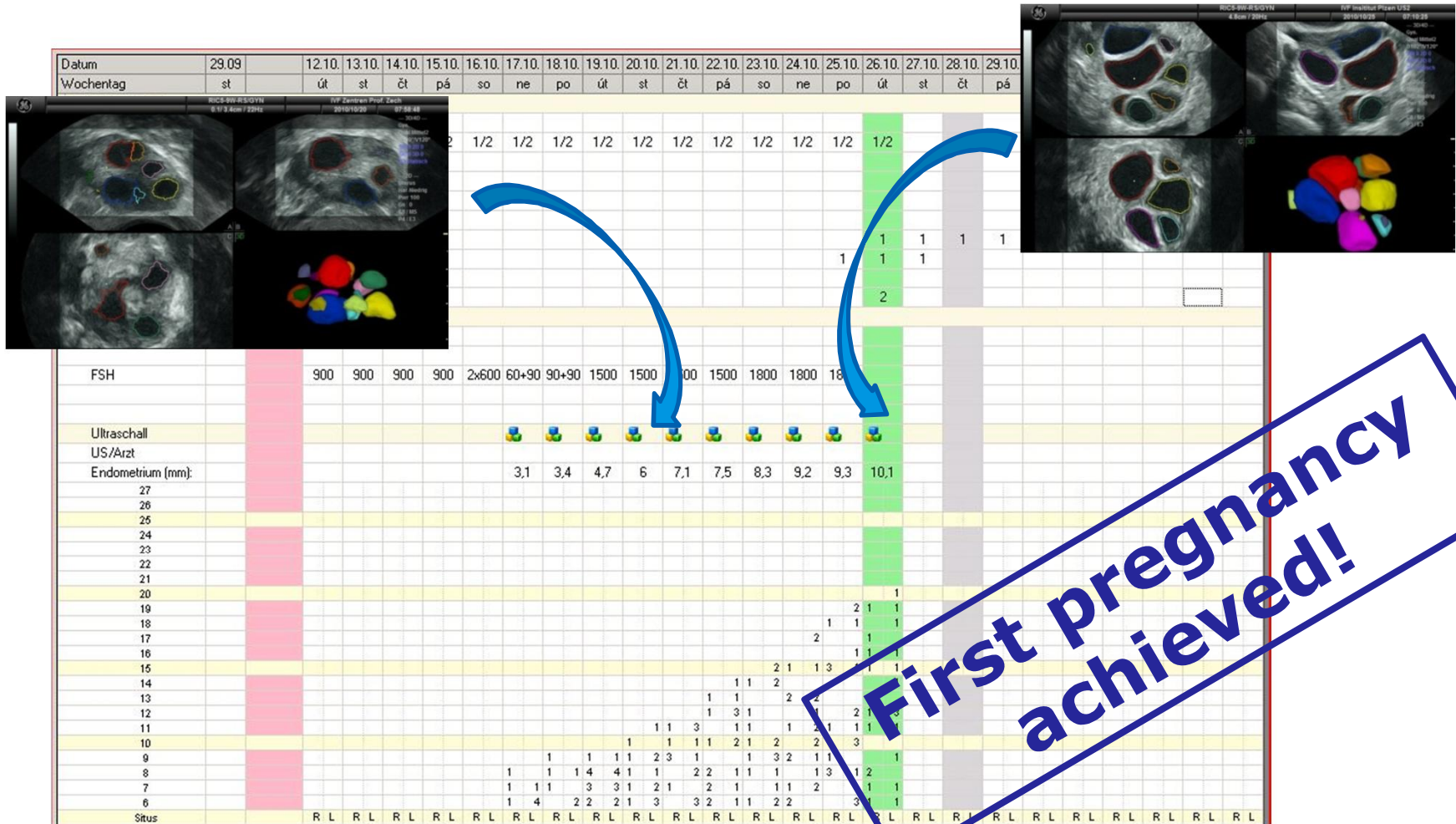

First pregnancy achieved!

in cooperation with LTS LOHMANN Therapie-Systeme AG

Intradermal delivery

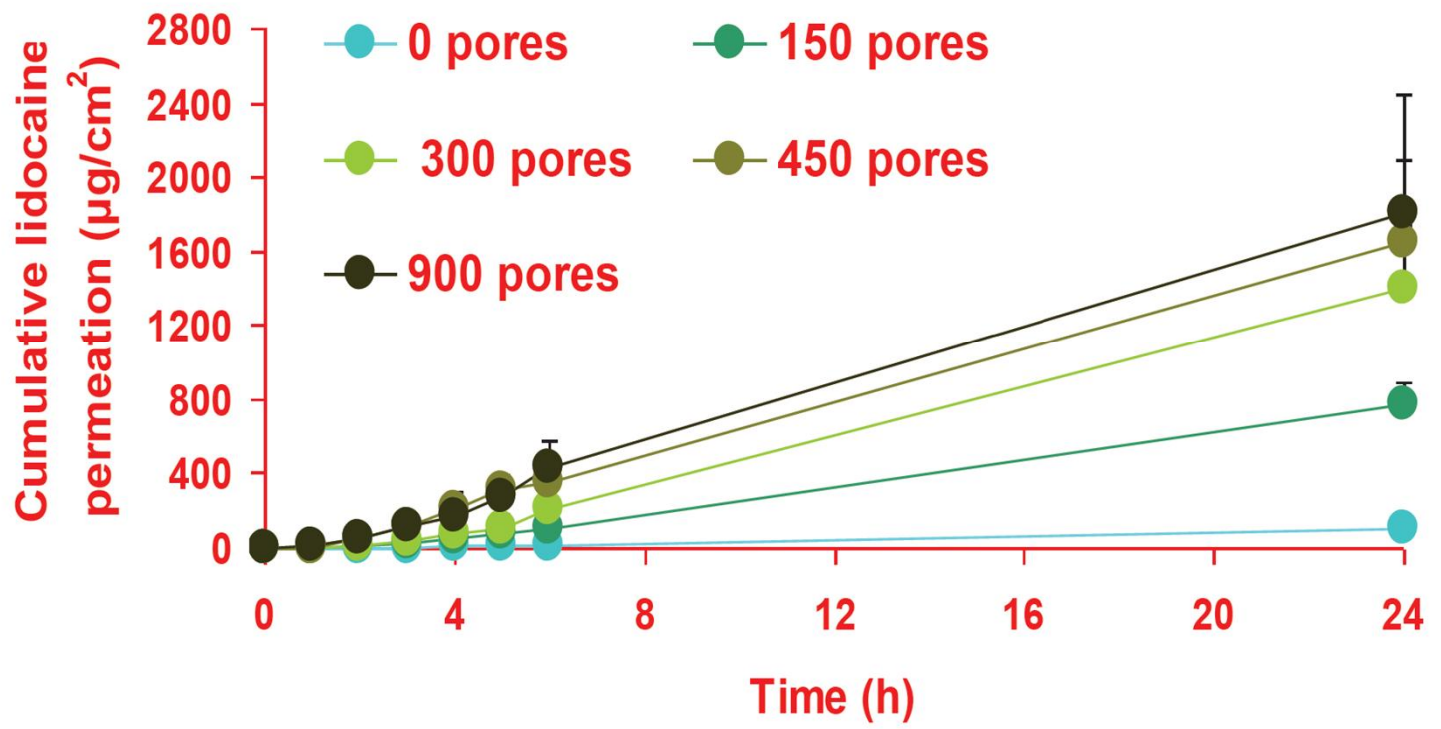

Intradermal delivery – sd-rxRNA™

sd-rxRNA™ = novel, small asymmetric, hydrophobically modified RNAi compound developed by RXi Pharmaceuticals

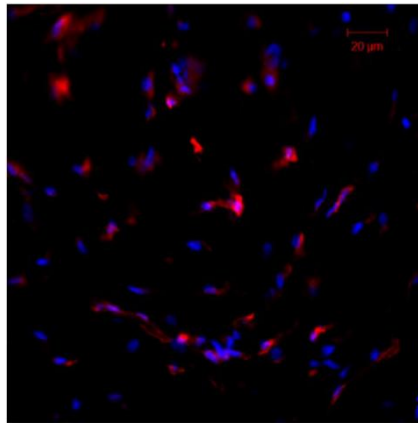

©2011 - I. Alberti - Study 6 - 5B(4) - Injected (2D-3x of 5B3)

Pig skin ex vivo, fibroblast transfection following ID injection

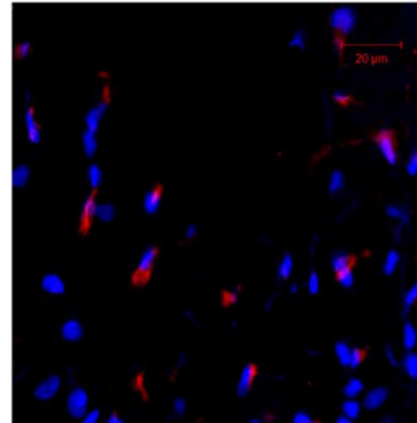

©2011 - I. Alberti - Study 6 - 3B(7) - Porated 5-250 (2D-3x of 3B5)

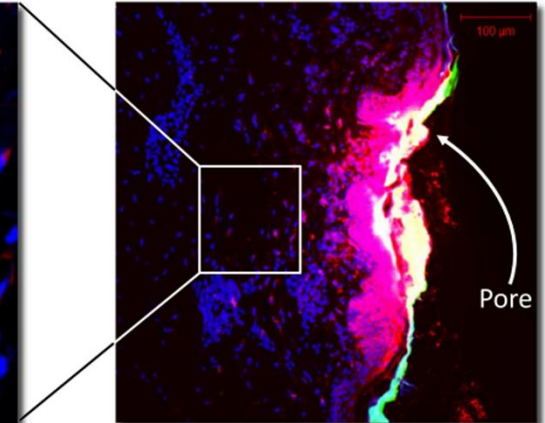

©2011 - I. Alberti - Study 6 - 3B(5)-Pored5-250(2D)

Evidence of dermal fibroblast transfection in P.L.E.A.S.E. microporated pig skin

Skin scar keloids: dermal fibrosis due to excessive expression of a protein, CTGF (connective tissue growth factor)

- Positive in vivo tests, siRNA uptake and gene silencing achieved by partner company
- Limitation: siRNA must currently be injected into scars
- P.L.E.A.S.E. is a less invasive method of delivery
- US potential market: up to \$4 billion

Conclusions - in vitro skin

- There is qualitative evidence for dermal siRNA delivery following skin microporation
- Cellular transfection patterns appear comparable to those obtained by ID injection

in cooperation with RXi Pharmaceuticals

Epidermal delivery (pre-clinical POC)

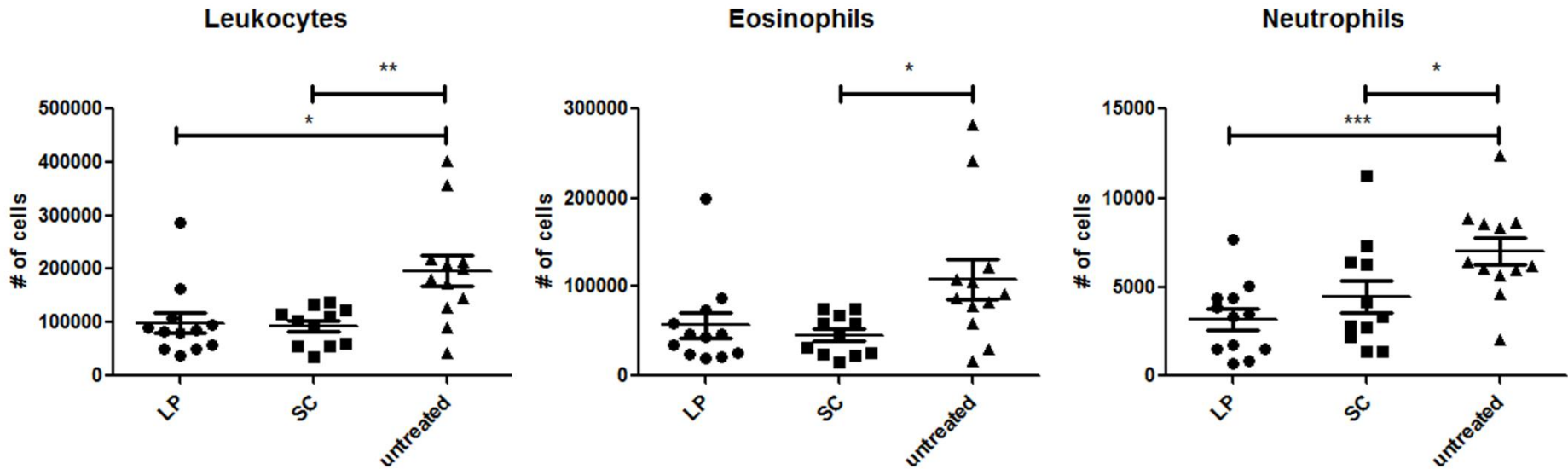

Mouse model of allergic asthma (rec. grass pollen) n=18 in 3 groups: control, 6 injections SCIT, 6 P.L.E.A.S.E.[®] treatments

Results

- Transcutaneous Immunotherapy via P.L.E.A.S.E.[®] generated micropores equals SIT in efficacy
- Transcutaneous Immunotherapy induces a different systemic immune profile than SCIT
- P.L.E.A.S.E.[®] IT induces a decrease of pro-inflammatory cytokines
- SCIT induces an unwanted boost of Th2 cells

in cooperation with Biomay AG

Epidermal delivery (pre-clinical POC)

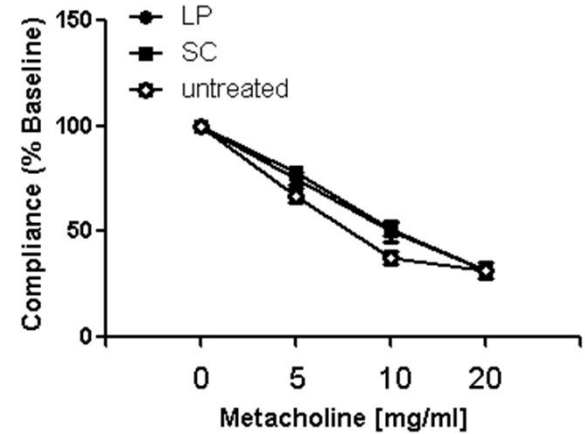
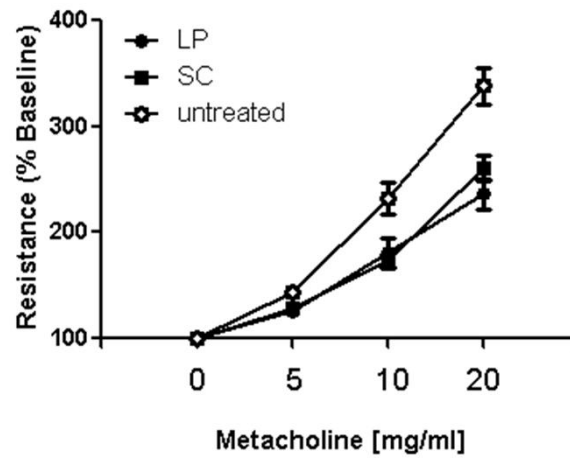
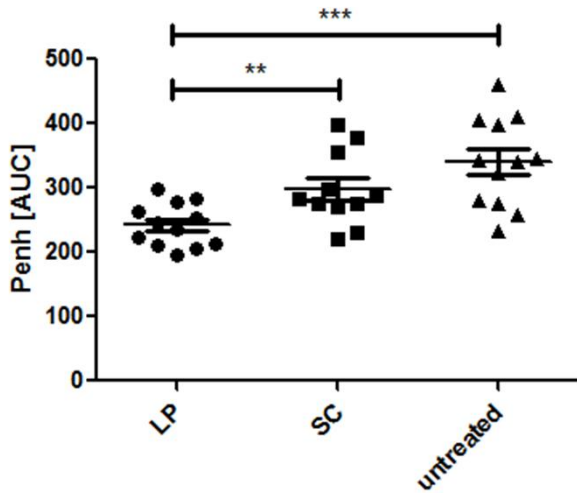

in cooperation with Biomay AG

P.L.E.A.S.E.® Professional technical summary

SYSTEM SPECIFICATIONS

Laser type:	Diode-pumped Er:YAG
Wavelength:	2940 nm
Average output power:	Up to 2 W
Pulse repetition rate:	100 to 500 Hz
Pulse duration:	50 to 225 µs
Beam profile:	Top-Hat
Pore diameter:	250 µm
Fluency:	Up to 25 J/cm ²
Aperture:	Variable, up to 14 x 14 mm
Pore density, coverage:	Variable, up to 15 %
Ablation depth:	Up to 2000 µm (theoretical value only!)

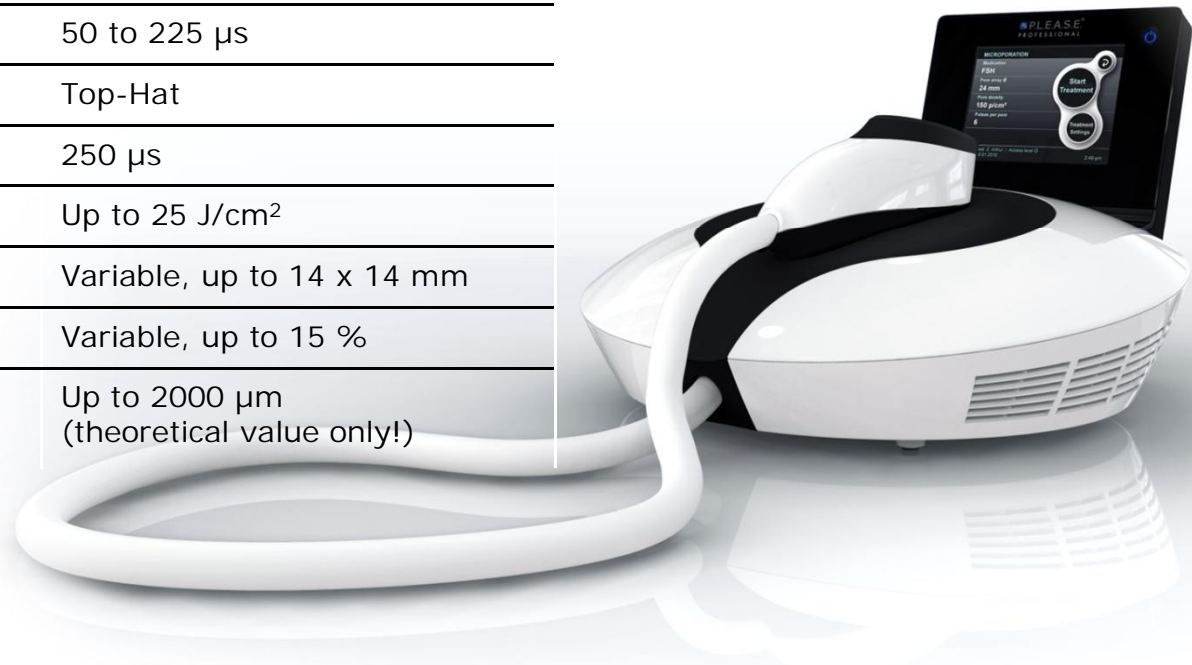

P.L.E.A.S.E.® Professional technical summary

Touch **screen with intuitive graphical interface**

Handheld unit **(65 x 220 x 90 mm WxDxH)**

Tabletop unit **(460 x 380 x 250 mm WxDxH)**

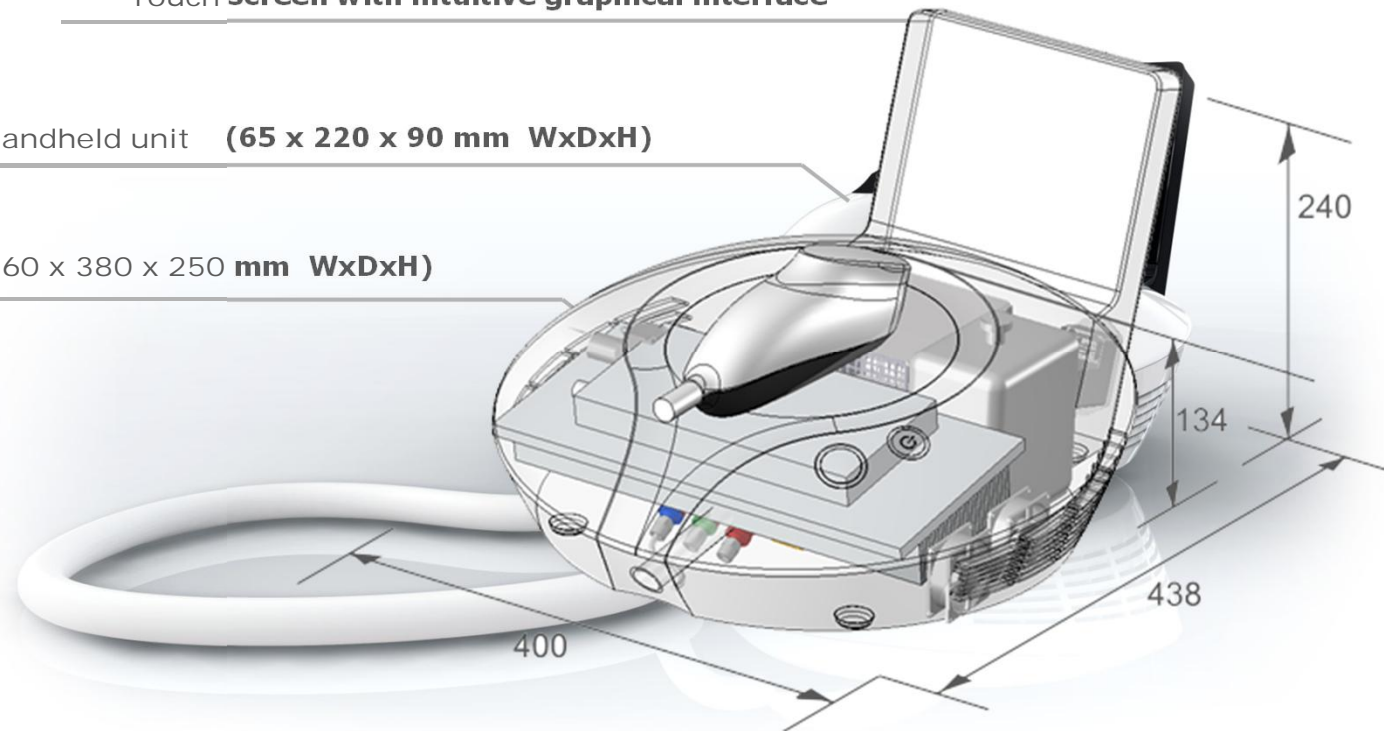

Pantec Biosolutions company profile

Location	Pantec Biosolutions AG Privately-owned Ruggell, Liechtenstein
Foundation	2005
Products	P.L.E.A.S.E.® Professional for dermatology applications P.L.E.A.S.E.® IVF (Hormone patches for IVF therapy in combination with P.L.E.A.S.E.®)
Employees	20 FTEs within Pantec Biosolutions, 10 FTEs in strategic partnerships



Collaborations

- ✦ Global & Regional
- ✦ Transdermal
- ✦ Intradermal
- ✦ Epidermal

You have a molecule that profits from dermal delivery?

We add delivery , know-how, formulation expertise and a new patent position!

P.L.E.A.S.E. Contact



Sven Rohmann, MD, PhD
CBO

Pantec Biosolutions AG
Industriering 21
9491 Ruggell
Liechtenstein

T: +423 377 78 00
F: +423 377 78 99

sven.rohmann@pantec-biosolutions.com

www.pantec-biosolutions.com